

2020



E. SASSONE

Made in Italy since 1953



GIUNTI TORSIONALI

TORSION DAMPERS





E. SASSONE

Via Castellero 12, 14013 Monale - Italy
tel. +39 0141 669691 - info@esassone.com



Complete clutch kits, pressure plates, clutch discs, hydraulic bearings, torsion dampers, brake discs, release bearings

Leader in the clutch business, **E. SASSONE** owes its success to a worldwide distribution strategy and being customer focused.



To meet its customers' requirements,
E. SASSONE:

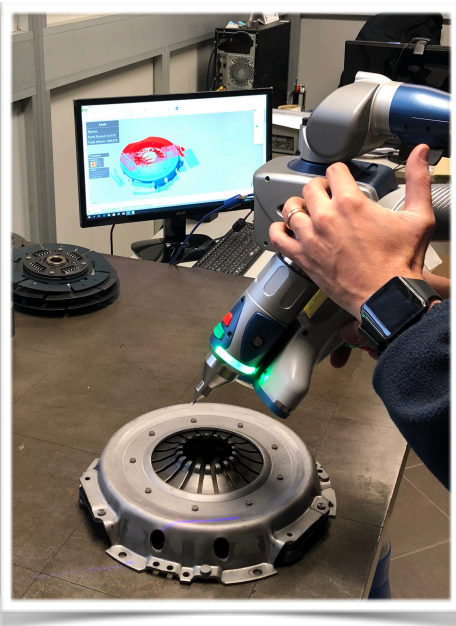

- Innovates in new products with enhanced functions.
- Adapts its products to the new automobile technologies.
- Takes the environment into account when designing and manufacturing products.

Uses quality tools and design and qualification methods resulting from the continual improvement processes in the automobile and agricultural industries.

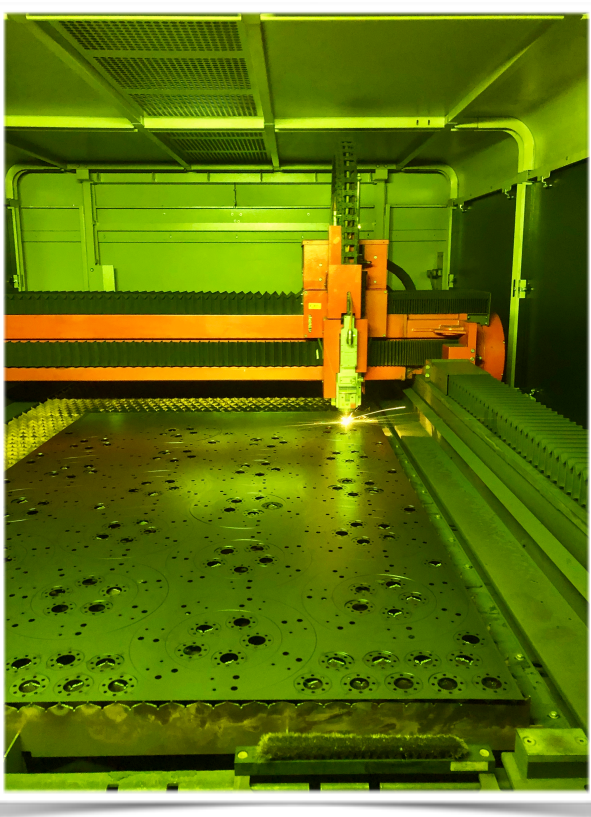
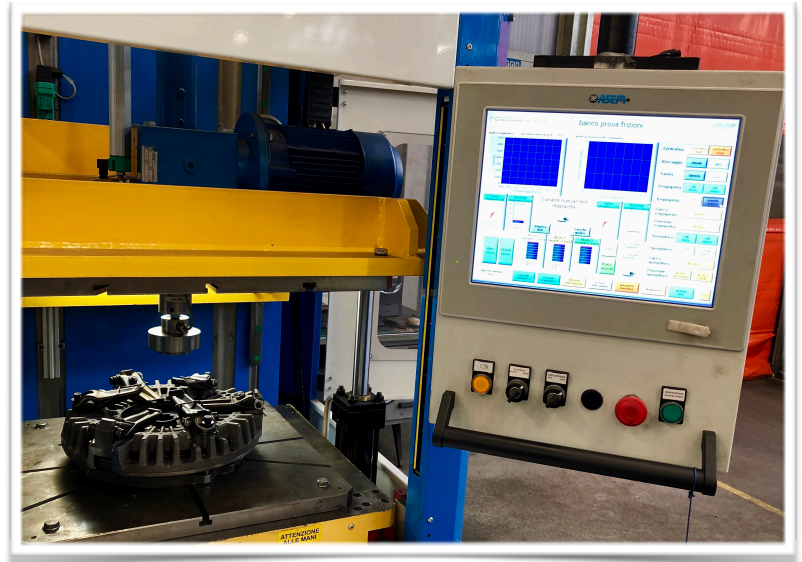

Do you want to develop an idea, solve a problem?

E. SASSONE is ready to innovate, design, develop to make your project successful.

E. SASSONE also offers an international presence to its customers in terms of both logistics and technical support.



www.esassone.com

E.SASSONE®

Fabbrica Dischi Frizione

Made in Italy since 1953



- Automobili
- Autobus e Camion
- Trattori
- Home
- News
- Chi siamo
- Download catalogues
- Certificati
- Official Distributors
- Contatti
- Fuori catalogo
- Offerta speciale!
- Museo

- Q E. SASSONE n°
- Q Cross reference



Frizione 2780

Codice	2780
Descrizione	(B11) - Clutch disc with 4 springs damper D=123 mm B11-P



Dimensioni	200x137x3,2
Splines	18,3x20,7x ev
Z	24

Frizione 2780 Applicazioni

A very high quality and competitive range.
A culture of innovation, technical support, planning development programs and a high-performance marketing media complete **E. SASSONE** 's strategy.

World clutches market leader, **E. SASSONE** is a top light supplier of automobile manufacturers and has developed a specific range for special application for racing and earthmovers machinery.

A team dedicated to the global market ensuring customer support and distribution of all **E. SASSONE** clutches necessary for the maintenance of all types of machinery.







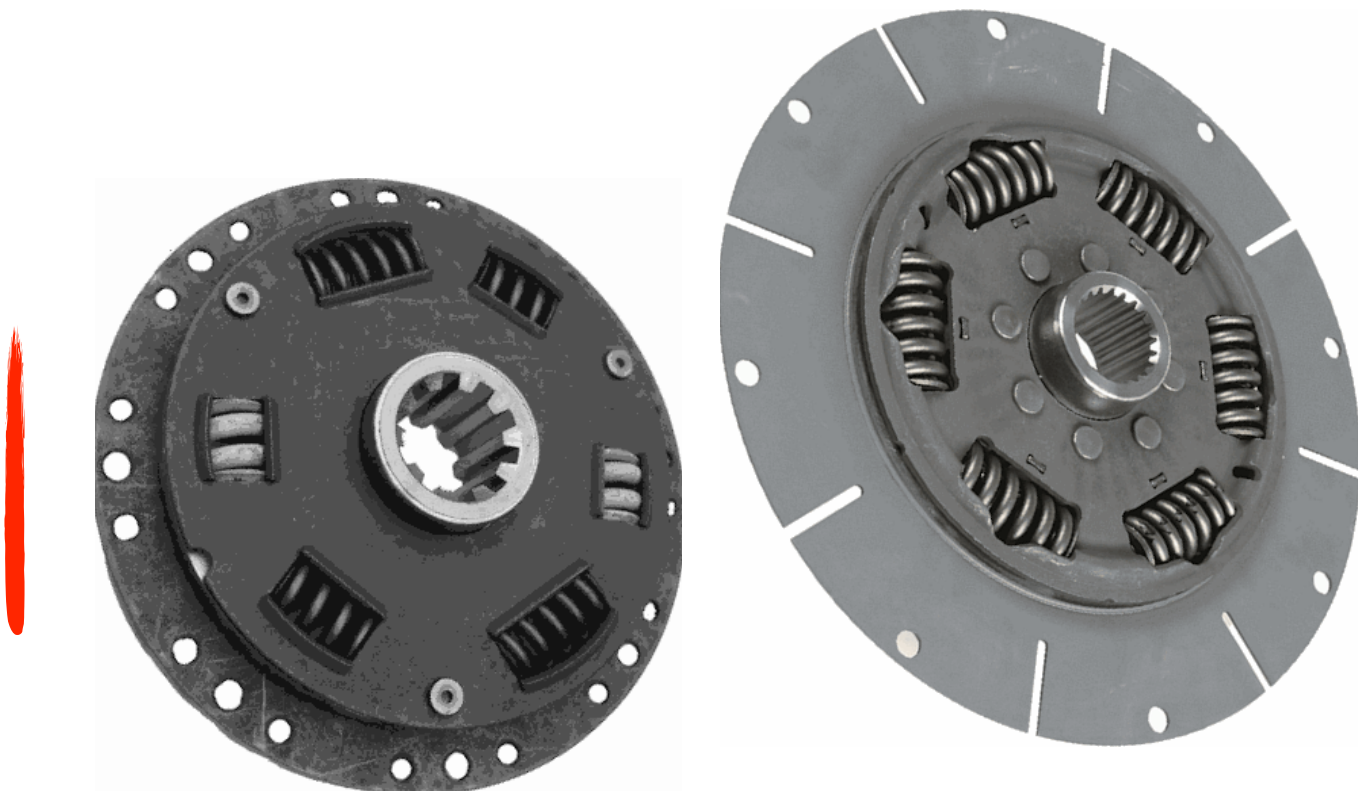

The **E. SASSONE** Quality, Health, Safety and Environment strategy is based on respect for man and his environment, to meet its customers' expectations.

This improves **E. SASSONE** 's overall performance and aims to achieve zero error, zero quality incidents, zero accidents and to minimize the environmental impacts of our various activities, products and services, from the design phase onwards.

E. SASSONE adheres to current regulations, guarantees categorical compliance with standard examinations and the compliance of its instruments to the regulatory requirements for instruments, meets customer's requirements and all other standard requirements.

To do this, **E. SASSONE** develops and implements a specific action plan with continuous improvement objectives.



					PARAMETER		
	Engine	Gearbox - Chassis	Year	Code	Ø	Z	Splines

AGCO

LT Series

75 - 75 A - 90 - 90 A				4764	352	26	39 x 42,5
75 - 75 A - 90 - 90 A				4771	295	26	39 x 42,5

AGROMECHANIKA

AGT

850T	38 kW			4732	224	14	22 x 25
------	-------	--	--	-------------	-----	----	---------

BCS

SYSTEM

40 AR - 40 RS	26 - 35 kW		00 ->	4732	224	14	22 x 25
50 LAR - 50 LRS	26 - 35 kW		00 ->	4732	224	14	22 x 25

VALIANT

400 AR - 400 RS	26 - 35 kW		00 ->	4732	224	14	22 x 25
500 LAR - 500 LRS	26 - 35 kW		00 ->	4732	224	14	22 x 25

VANGUARD

750 AR - 750 RS	51 - 55 kW		00 ->	4365	225	16	27 x 30
800 AR - 800 RS	51 - 55 kW		00 ->	4365	225	16	27 x 30

CASE IH





MAXIMA





JX 70U		Powershift	02 ->	4669	263	14	35 x 40
JX 80U		Powershift	02 ->	4669	263	14	35 x 40
JX 90U		Powershift	02 ->	4669	263	14	35 x 40
JX 100U			02 ->	4669	263	14	35 x 40
JX 1070U	53 kW	Powershift	04 ->	4669	263	14	35 x 40
JX 1080U - 1090U		Powershift	04 ->	4669	263	14	35 x 40
JX 1100U		Powershift	04 ->	4669	263	14	35 x 40





MAXXUM

MXM 110 - 120 - 130	81 - 89 - 96 kW		11 ->	4779	348	16	31 x 35
MXM 120 - 130		Full powershift	02 ->	4775	348	14	35 x 40
MXM 120 - 130		Semi powershift	02 ->	4609	348	14	35 x 40
MXM 135		Chass. 304203 ->	02 ->	4609	348	14	35 x 40
MXM 140 - 150		Full powershift	02 ->	4775	348	14	35 x 40
MXM 140		Semi powershift	02 ->	4609	348	14	35 x 40
MXM 150		Chass. 304203 ->	02 ->	4609	348	14	35 x 40
MXM 155		Semi powershift	02 ->	4609	348	14	35 x 40
MXM 165		Chass. 304203 ->	02 ->	4609	348	14	35 x 40
MXM 180		Chass. 304203 ->	02 ->	4609	348	14	35 x 40
MXM 190			02 ->	4775	348	14	35 x 40
MXU 100		Full powershift	03 ->	4666	263	16	31 x 35
MXU 115		Full powershift	03 ->	4666	263	16	31 x 35

		 Engine	 Gearbox - Chassis	 Year	 Code	PARAMETER		
						Ø	Z	Splines
PUMA								
115		86 kW		07 ->	4775	348	14	35 x 40
125		93 - 120 kW		07 ->	4775	348	14	35 x 40
140		104 - 129 kW		07 ->	4775	348	14	35 x 40
155		117 - 142 kW		07 ->	4775	348	14	35 x 40
160		149 kW		08 ->	4775	348	14	35 x 40
165		123 kW		08 ->	4775	348	14	35 x 40
180		134 kW		07 ->	4775	348	14	35 x 40
195		145 kW		07 ->	4775	348	14	35 x 40
210		157 kW		07 ->	4775	348	14	35 x 40
CATERPILLAR								
LEXION								
560		232 kW	Max. torque 3415 Nm.		6305	435	24	46 x 50
570 R		261 kW	Max. torque 3415 Nm.		6305	435	24	46 x 50
575 R		261 kW	Max. torque 3415 Nm.		6305	435	24	46 x 50
580 R		317 kW	Max. torque 3415 Nm.		6305	435	24	46 x 50
585 R		317 kW	Max. torque 3415 Nm.		6305	435	24	46 x 50
590 R		385 kW	Max. torque 3415 Nm.		6305	435	24	46 x 50
730		232 kW	Max. torque 3415 Nm.		6305	435	24	46 x 50
740		261 kW	Max. torque 3415 Nm.		6305	435	24	46 x 50
750		317 kW	Max. torque 3415 Nm.		6305	435	24	46 x 50
760		350 kW	Max. torque 3415 Nm.		6305	435	24	46 x 50
770		390 kW	Max. torque 3415 Nm.		6305	435	24	46 x 50
CHALLENGER								
MT Series								
425 B		60 kW			4764	352	26	39 x 42,5
425 B		60 kW			4771	295	26	39 x 42,5
445 B		67 kW			4764	352	26	39 x 42,5
445 B		67 kW			4771	295	26	39 x 42,5
455 B		74 kW			4764	352	26	39 x 42,5
455 B		74 kW			4771	295	26	39 x 42,5
465 B		84 kW			4764	352	26	39 x 42,5
465 B		84 kW			4771	295	26	39 x 42,5
525 B		73 kW			4772	295	26	39 x 42,5
535 B		82 kW			4772	295	26	39 x 42,5
545 B		89 kW			4772	295	26	39 x 42,5
CLAAS								
ARES								
540 RX - RZ					4776	295	26	39 x 42,5
546 RX - RZ					4776	295	26	39 x 42,5
550 RX - RZ					4776	295	26	39 x 42,5
556 RX - RZ					4776	295	26	39 x 42,5

		 Engine	 Gearbox - Chassis	 Year	 Code	PARAMETER		
						Ø	Z	Splines
AXION								
810		151 - 158 kW		12 ->	4778	348	26	39 x 42,5
820		139-145 kW		12 ->	4778	348	26	39 x 42,5
830		165 - 173 kW		12 ->	4778	348	26	39 x 42,5
850		184 - 194 kW		12 ->	4778	348	26	39 x 42,5
JAGUAR								
810		220 kW	Max. torque 3415 Nm.		6305	435	24	46 x 50
830		270 kW	Max. torque 3415 Nm.		6305	435	24	46 x 50
850		315 kW	Max. torque 3415 Nm.		6305	435	24	46 x 50
870		350 kW	Max. torque 3415 Nm.		6305	435	24	46 x 50
890		390 kW	Max. torque 3415 Nm.		6305	435	24	46 x 50
900		480 kW	Max. torque 3415 Nm.		6305	435	24	46 x 50
930		315 kW	Max. torque 3415 Nm.		6305	435	24	46 x 50
940		350 kW	Max. torque 3415 Nm.		6305	435	24	46 x 50
950		390 kW	Max. torque 3415 Nm.		6305	435	24	46 x 50
960		480 kW	Max. torque 3415 Nm.		6305	435	24	46 x 50
970		555 kW	Max. torque 3415 Nm.		6305	435	24	46 x 50
980		630 kW	Max. torque 3415 Nm.		6305	435	24	46 x 50
LEXION								
510		173 kW	Max. torque 3415 Nm.	03 -> 10	6305	435	24	46 x 50
510		173 kW	Max. torque 2030 Nm.	03 -> 10	4665	352	24	45 x 50
520		203 kW	Max. torque 3415 Nm.	03 -> 10	6305	435	24	46 x 50
520		203 kW	Max. torque 2030 Nm.	03 -> 10	4665	352	24	45 x 50
530		260 kW	Max. torque 3415 Nm.	03 -> 10	6305	435	24	46 x 50
530		260 kW	Max. torque 2030 Nm.	03 -> 10	4665	352	24	45 x 50
540		230 kW	Max. torque 3415 Nm.	03 -> 10	6305	435	24	46 x 50
540		230 kW	Max. torque 2030 Nm.	03 -> 10	4665	352	24	45 x 50
550		258 kW	Max. torque 3415 Nm.	03 -> 10	6305	435	24	46 x 50
550		258 kW	Max. torque 2030 Nm.	03 -> 10	4665	352	24	45 x 50
560		283 kW	Max. torque 3415 Nm.	03 -> 10	6305	435	24	46 x 50
560		283 kW	Max. torque 2030 Nm.	03 -> 10	4665	352	24	45 x 50
570		282 kW	Max. torque 3415 Nm.	03 -> 10	6305	435	24	46 x 50
570		282 kW	Max. torque 2030 Nm.	03 -> 10	4665	352	24	45 x 50
580		340 kW	Max. torque 3415 Nm.	03 -> 10	6305	435	24	46 x 50
580		340 kW	Max. torque 2030 Nm.	03 -> 10	4665	352	24	45 x 50
600		390 kW	Max. torque 3415 Nm.	03 -> 10	6305	435	24	46 x 50
600		390 kW	Max. torque 2030 Nm.	03 -> 10	4665	352	24	45 x 50
620		205 kW	Max. torque 3415 Nm.	10 ->	6305	435	24	46 x 50
620		205 kW	Max. torque 2030 Nm.	10 ->	4665	352	24	45 x 50
630		230 kW	Max. torque 3415 Nm.	10 ->	6305	435	24	46 x 50
630		230 kW	Max. torque 2030 Nm.	10 ->	4665	352	24	45 x 50
640		205 kW	Max. torque 3415 Nm.	10 ->	6305	435	24	46 x 50
640		205 kW	Max. torque 2030 Nm.	10 ->	4665	352	24	45 x 50
650		230 kW	Max. torque 3415 Nm.	10 ->	6305	435	24	46 x 50
650		230 kW	Max. torque 2030 Nm.	10 ->	4665	352	24	45 x 50
660		261 kW	Max. torque 3415 Nm.	10 ->	6305	435	24	46 x 50

	 Engine	 Gearbox - Chassis	 Year	 Code	PARAMETER		
					Ø	Z	Splines
660	261 kW	Max. torque 2030 Nm.	10 ->	4665	352	24	45 x 50
670	287 kW	Max. torque 3415 Nm.	10 ->	6305	435	24	46 x 50
670	287 kW	Max. torque 2030 Nm.	10 ->	4665	352	24	45 x 50
740	287 kW	Max. torque 3415 Nm.	10 ->	6305	435	24	46 x 50
740	287 kW	Max. torque 2030 Nm.	10 ->	4665	352	24	45 x 50
750	317 kW	Max. torque 3415 Nm.	10 ->	6305	435	24	46 x 50
750	317 kW	Max. torque 2030 Nm.	10 ->	4665	352	24	45 x 50
760	350 kW	Max. torque 3415 Nm.	10 ->	6305	435	24	46 x 50
760	350 kW	Max. torque 2030 Nm.	10 ->	4665	352	24	45 x 50
770	390 kW	Max. torque 3415 Nm.	10 ->	6305	435	24	46 x 50
770	390 kW	Max. torque 2030 Nm.	10 ->	4665	352	24	45 x 50
550 Montana	258 kW	Max. torque 3415 Nm.	03 -> 10	6305	435	24	46 x 50
550 Montana	258 kW	Max. torque 2030 Nm.	03 -> 10	4665	352	24	45 x 50
560 Montana	283 kW	Max. torque 3415 Nm.	03 -> 10	6305	435	24	46 x 50
560 Montana	283 kW	Max. torque 2030 Nm.	03 -> 10	4665	352	24	45 x 50
570 Montana	282 kW	Max. torque 3415 Nm.	03 -> 10	6305	435	24	46 x 50
570 Montana	282 kW	Max. torque 2030 Nm.	03 -> 10	4665	352	24	45 x 50
580 Australia	340 kW	Max. torque 3415 Nm.	03 -> 10	6305	435	24	46 x 50
580 Australia	340 kW	Max. torque 2030 Nm.	03 -> 10	4665	352	24	45 x 50
580 R	340 kW	Max. torque 3415 Nm.	03 -> 10	6305	435	24	46 x 50
580 R	340 kW	Max. torque 2030 Nm.	03 -> 10	4665	352	24	45 x 50
TUCANO							
320	140 kW	Max. torque 2030 Nm.	07 ->	4665	352	24	45 x 50
330	177 kW	Max. torque 2030 Nm.	07 ->	4665	352	24	45 x 50
340	192 kW	Max. torque 2030 Nm.	07 ->	4665	352	24	45 x 50
430	177 kW	Max. torque 2030 Nm.	07 ->	4665	352	24	45 x 50
440	192 kW	Max. torque 2030 Nm.	07 ->	4665	352	24	45 x 50
450	203 kW	Max. torque 2030 Nm.	07 ->	4665	352	24	45 x 50
470	240 kW	Max. torque 2030 Nm.	09 ->	4665	352	24	45 x 50
480	268 kW	Max. torque 3415 Nm.	09 ->	6305	435	24	46 x 50
DEUTZ							
AGROPLUS							
75 A	55 kW		98 -> 04	4607	263	24	46 x 50
85 - 95	62 - 68 kW		98 -> 04	4607	263	24	46 x 50
100	73 kW		98 -> 04	4607	263	24	46 x 50
AGROTRON							
4.70 - 4.80 - 4.85 - 4.90 - 4.95		Powershift		4666	263	16	31 x 35
6.01		Powershift		4666	263	16	31 x 35
80		Powershift		4666	263	16	31 x 35
80 MK3		Powershift		4666	263	16	31 x 35
85		Powershift		4666	263	16	31 x 35
85 MK3		Powershift		4666	263	16	31 x 35
90		Powershift		4666	263	16	31 x 35
90 MK3		Powershift		4666	263	16	31 x 35
100		Powershift		4666	263	16	31 x 35
100 MK3 - 105 - 105 MK3 - 106		Powershift		4666	263	16	31 x 35

					PARAMETER		
	Engine	Gearbox - Chassis	Year	Code	Ø	Z	Splines

FARNY & WEIDMANN

A - V

R - P - S		Max. torque 154 Nm		4199	121,5	10	23 x 29
R - P - S				4200	151	10	23 x 29
R - P - S		Max. torque 300 Nm		4454	151	26	31,8 x 34,3

FERRARI

COBRAM

40AR - 40RS - 50LAR - 50LRS			00 ->	4732	224	14	22 x 25
-----------------------------	--	--	-------	-------------	-----	----	---------

SYSTEM

40AR - 40RS - 50LAR - 50LRS			00 ->	4732	224	14	22 x 25
55AR - 55RS			00 ->	4365	225	16	27 x 30
75AR - 75MT - 75RS - 80MT - 80RS			00 ->	4365	225	16	27 x 30

IMT

5000 - 6000

5160	180 - 200 PS	Max. torque 2200 Nm		6589	250	32	64 x 70
5200	180 - 200 PS	Max. torque 2200 Nm		6589	250	32	65 x 70

IVECO

P - PA

160-23 AH - AHW	168 kW	Max. torque 2200 Nm	84 -> 89	6589	250	32	64 x 70
170-25 AH	194 kW	Max. torque 2200 Nm	91 -> 93	6589	250	32	64 x 70
180-25 AH	194 kW	Max. torque 2200 Nm	91 -> 93	6589	250	32	64 x 70
190-25 AN	188 kW	Max. torque 2200 Nm	83 -> 93	6589	250	32	64 x 70

260

260-32				6589	250	32	64 x 70
--------	--	--	--	-------------	-----	----	---------

330

330-26 H				6589	250	32	64 x 70
330-32 ANW				6589	250	32	64 x 70
330-35 H - HT - HW				6589	250	32	64 x 70
330-36 H	265 kW	Max. torque 2180 Nm		6594	250	32	64 x 70
330 PC 35				6589	250	32	64 x 70
330 PT 35				6589	250	32	64 x 70

HÜRLIMANN

XT Serie





908	59 kW		96 ->	4607	263	24	46 x 50
909	66 kW		96 ->	4607	263	24	46 x 50
910.4 - 910.6	74 kW		96 ->	4607	263	24	46 x 50

JOHN DEERE

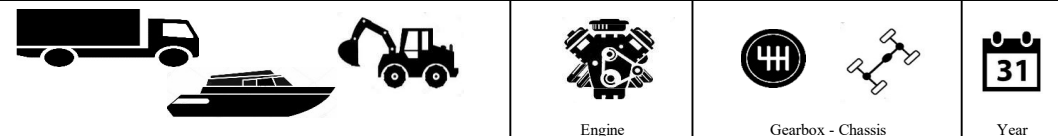



820 - 1030

830		Max. torque 527 Nm		4304	193	23	35 x 38,5
930		Max. torque 527 Nm		4304	193	23	35 x 38,5
1020 - 1020 V		Max. torque 527 Nm		4304	193	23	35 x 38,5
1030	35 kW	Max. torque 527 Nm		4304	193	23	35 x 38,5

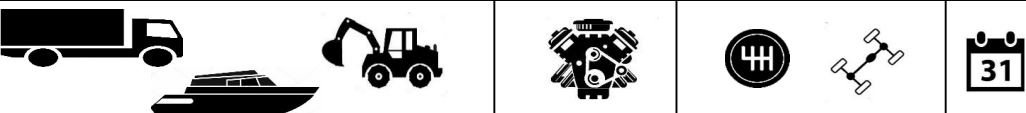
			PARAMETER				
	Engine	Gearbox - Chassis	Year	Code	Ø	Z	Splines
1040 - 1550							
1120		Max. torque 527 Nm		4304	193	23	35 x 38,5
1130		Max. torque 527 Nm		4304	193	23	35 x 38,5
1630 - 1950							
1630		Max. torque 527 Nm		4304	193	23	35 x 38,5
1830		Max. torque 527 Nm		4304	193	23	35 x 38,5
2000 - 2040							
2030		Max. torque 527 Nm		4304	193	23	35 x 38,5
2100 - 2240							
2130		Max. torque 527 Nm		4304	193	23	35 x 38,5
KÄSSBOHRER							
Pistenbully							
Pistenbully		Max. torque 2030 Nm		6561	352	21	41x45
Pistenbully				6588	265	14	22 x 25
KRONE							
BIG X							
480 - 530 - 580 - 630		Max. torque 4112 Nm		6573	475	24	46 x 50
LAMBORGHINI							
PREMIUM							
850	63 KW		96 ->	4607	263	24	46 x 50
950	70 KW		96 ->	4607	263	24	46 x 50
1050	75 KW		96 ->	4607	263	24	46 x 50
1060	75 KW		96 ->	4607	263	24	46 x 50
LANDINI							
LAND POWER							
125	86 kW	Max. torque 1300 Nm	08 ->	4765	295	26	50,4 x 54,6
135 - 145	98 - 104 KW	Max. torque 1300 Nm	08 ->	4765	295	26	50,4 x 54,6
165	116 KW	Max. torque 1300 Nm	08 ->	4765	295	26	50,4 x 54,6
LEGEND TOP							
105 - 115 - 120 - 130 - 145 - 160 - 165 - 180	76 - 117 kW	Max. torque 1300 Nm		4765	295	26	50,4 x 54,6
MISTRAL							
40 - 45 - 50				4727	280	14	22 x 25
MYTHOS							
90 - 100 - 110	67 - 74 - 79 KW	Max. torque 1300 Nm		4666	263	16	31 x 35
REX							
60 F - 70 F - 70 GE - 85 F - 85 GE	50 - 58 kW	Max. torque 1300 Nm		4666	263	16	31 x 35
75 F - 80 F - 90 F	54 - 61 kW	Max. torque 1300 Nm		4666	263	16	31 x 35
100 F - 110 F	68 - 75 kW	Max. torque 1300 Nm		4666	263	16	31 x 35
120 F	81 kW	Max. torque 1300 Nm		4666	263	16	31 x 35
VISION							
80	59 kW	Max. torque 1300 Nm		4666	263	16	31 x 35
85 - 95	61 - 68 kW	Max. torque 1300 Nm		4666	263	16	31 x 35
90	67 kW	Max. torque 1300 Nm		4666	263	16	31 x 35
100 - 105	68 - 75 kW	Max. torque 1300 Nm		4666	263	16	31 x 35

		 Engine	 Gearbox - Chassis	 Year	 Code	PARAMETER		
						Ø	Z	Splines
LIEBHERR								
Wheel loader								
L 544 -> L 580			Max. torque 2490 Nm		6393	345	18	54 x 60
L 538 - L542			Max. torque 2719 Nm		6392	466	18	36,2x40,6
Crane								
LTM 1085 OW			Max. torque 2719 Nm		6391	466	18	36,2x40,6
Crawler excavator								
R 317			Max. torque 670 Nm		6150	315	18	36 x 40
R 317			Max. torque 1240 Nm		6394	314	21	41 x 45
R 317	90 kW		Max. torque 670 Nm		6150	314	18	36 x 40
R 321 - R 902 LI			Max. torque 820 Nm		6389	345	16	31 x 35
R 321 - R 902 LI			Max. torque 823 Nm		6389	345	16	31 x 35
R 324			Max. torque 2720 Nm		6395	345	24	46 x 50
R 900 LI			Max. torque 670 Nm		6390	314	16	31 x 35
R 900 LI			Max. torque 670 Nm		6390	314	16	31 x 35
R 912			Max. torque 1420 Nm		6063	345	18	36 x 40
R 912			Max. torque 2573 Nm		6570	345	18	36 x 40
R 932 LI - 934 B/T - 942 LI - 944			Max. torque 1580 Nm		6155	345	24	45 x 50
R 932 LI - 934 B/T - 942 LI - 944			Max. torque 2500 Nm		6571	345	24	46 x 50
R 934 C			Max. torque 1580 Nm		6155	345	24	45 x 50
R 934 C			Max. torque 3415 Nm		6396	345	24	46 x 50
R 942			Max. torque 2500 Nm		6569	345	22	41 x 45
R 944 T CU			Max. torque 3415 Nm		6396	345	24	46 x 50
R 952 - 952 LI - 962-133/225/226/385			Max. torque 1950 Nm		6574	390	18	54 x 60
Mobile excavator								
A 312	75 kW		Max. torque 670 Nm		6150	314	18	36 x 40
A 314	90 kW		Max. torque 670 Nm		6150	314	18	36 x 40
A 316	94 kW		Max. torque 670 Nm		6150	314	18	36 x 40
A 900 C-ZW			Max. torque 1810 Nm		6397	345	24	46 x 50
A 900 LI - A 900 ZW			Max. torque 670 Nm		6390	314	16	31 x 35
A 902 - A 902 LI			Max. torque 823 Nm		6389	345	16	31 x 35
A 904	99 kW		Max. torque 2573 Nm		6570	345	18	36 x 40
A 904 C - HD	105 kW		Max. torque 2573 Nm		6570	345	18	36 x 40
A 912			Max. torque 2573 Nm		6570	345	18	36 x 40
A 914 - B			Max. torque 2573 Nm		6570	345	18	36 x 40
A 922 - HD			Max. torque 2573 Nm		6570	345	18	36 x 40
A 924 B - HD			Max. torque 2573 Nm		6570	345	18	36 x 40
A 932 LI			Max. torque 2500 Nm		6571	345	24	46 x 50
A 934 B - LI			Max. torque 2500 Nm		6571	345	24	46 x 50
A 934 CL I			Max. torque 3415 Nm		6396	345	24	46 x 50
A 934 LI			Max. torque 2500 Nm		6571	345	24	46 x 50
A 942			Max. torque 2500 Nm		6569	345	22	41 x 45
A 944 LI			Max. torque 2500 Nm		6571	345	24	46 x 50

			PARAMETER Ø Z Splines				
LOMBARDINI							
TRACTOR							
Coupling				4200	151	10	23 x 29
Coupling				4199	121,5	10	23 x 29
MAGIRUS - DEUTZ							
250							
256 D 16 SS		Max. torque 2200 Nm		6589	250	32	64 x 70
256 M 19 K		Max. torque 2200 Nm		6589	250	32	64 x 70
310							
310 D 22 FA	Version 42230008	Max. torque 2200 Nm		6589	250	32	64 x 70
310 D 26 FAK	Version 42241400	Max. torque 2200 Nm		6589	250	32	64 x 70
320							
320 M FAK		Max. torque 2200 Nm		6589	250	32	64 x 70
MASSEY-FERGUSON							
TRACTOR							
5465	90 kW		04 -> 07	4772	295	26	39 x 42,5
6235	55 kW		04 ->	4764	352	26	39 x 42,5
6235	55 kW		04 ->	4771	295	26	39 x 42,5
6470	92 kW		04 ->	4764	352	26	39 x 42,5
4225 - 4235 - 4255 - 4260 - 4270			97 -> 01	4777	295	25	38,2 x 41,5
5425 - 5435 - 5445 - 5455 - 5460 - 5465	56 -> 86 kW		04 ->	4771	295	26	39 x 42,5
5425 - 5435 - 5445 - 5455 - 5460 - 5465	56 -> 86 kW	POWERSHUTTLE	04 ->	4764	352	26	39 x 42,5
6170 - 6180 - 6190	90 -> 97 kW		04 -> 07	4772	295	26	39 x 42,5
6260 - 6270 - 6280 - 6290	77 -> 100 kW		04 -> 07	4772	295	26	39 x 42,5
6445 - 6455 - 6460	70 -> 92 kW		04 ->	4764	352	26	39 x 42,5
6445 - 6455 - 6460	70 -> 92 kW		04 ->	4771	295	26	39 x 42,5
6465 - 6475 - 6480	87 -> 107 kW		04 ->	4772	295	26	39 x 42,5
6485 - 6490 - 6495 - 6497 - 6499	116 -> 147 kW		04 -> 07	4773	348	26	39 x 42,5
7485 - 7490 - 7495	116 -> 138 kW		04 -> 07	4773	348	26	39 x 42,5
8110 S - 8120 - 8130 - 8140 - 8150 - 8160	99 -> 147 kW		96 ->	4770	352	26	39 x 42,5
8210 - 8220 - 8240 - 8250	107 - 136 kW		00 ->	4773	348	26	39 x 42,5
8210 - 8220 - 8240 - 8250 - 8260		FULL POWERSHIFT/FUNK	00 ->	4770	352	26	39 x 42,5
MF Serie							
7619 - 7620 - 7622	136 -> 158 kW		11 ->	4773	348	26	39 x 42,5
MC CORMICK							
F Serie							
70 F - 85 F	50 - 58 kW	Max. torque 1300	09 ->	4765	295	26	50,4 x 54,6
80 F - 90 F	54 - 61 kW	Max. torque 1300	09 ->	4765	295	26	50,4 x 54,6
100 F - 110 F	68 - 75 kW	Max. torque 1300	09 ->	4765	295	26	50,4 x 54,6
120 F	81 kW	Max. torque 1300	09 ->	4765	295	26	50,4 x 54,6
MC Serie							
80 - 90 - 10		Chass. -> JJE 2020668			354	13	38,3 x 45,6
80 - 90 - 10		Chass. JJE 2020669 ->			354	13	38,3 x 45,6
95 - 105 - 115					354	13	38,3 x 45,6

					PARAMETER		
	Engine	Gearbox - Chassis	Year	Code	Ø	Z	Splines

MENGELE

Field Chopper

Mammut 6900 - 7400 - 7800		Max. torque 2540 Nm.		4672	352	24	45 x 50
SF 5200-5600-6000-6500-6600-7000		Max. torque 2190 Nm.		4671	352	22	41 x 45

MERCEDES-BENZ

1729

1729 ...		Max. torque 2180 Nm	87 -> 96	6594	250	32	64 x 70
----------	--	---------------------	----------	-------------	-----	----	---------

1735

1735 ...		Max. torque 2180 Nm	87 -> 96	6594	250	32	64 x 70
----------	--	---------------------	----------	-------------	-----	----	---------

1748

1748 ...		Max. torque 2180 Nm	87 -> 96	6594	250	32	64 x 70
----------	--	---------------------	----------	-------------	-----	----	---------

1827

1827 ...		Max. torque 2180 Nm	87 -> 96	6594	250	32	64 x 70
----------	--	---------------------	----------	-------------	-----	----	---------

1831

1831 ...		Max. torque 2180 Nm	87 -> 96	6594	250	32	64 x 70
----------	--	---------------------	----------	-------------	-----	----	---------

1838

1838 ...		Max. torque 2180 Nm	90 -> 96	6594	250	32	64 x 70
----------	--	---------------------	----------	-------------	-----	----	---------

1844

1844	320 kW	Max. torque 2180 Nm		6594	250	32	64 x 70
------	--------	---------------------	--	-------------	-----	----	---------

1850

1850 ...	370 kW	Max. torque 2180 Nm	88 -> 94	6594	250	32	64 x 70
----------	--------	---------------------	----------	-------------	-----	----	---------

1853

1853 AK	390 kW	Max. torque 2180 Nm	96	6594	250	32	64 x 70
---------	--------	---------------------	----	-------------	-----	----	---------

1929

1929 ...		Max. torque 2180 Nm	87 -> 96	6594	250	32	64 x 70
----------	--	---------------------	----------	-------------	-----	----	---------

1935

1935 ...		Max. torque 2180 Nm	89 -> 94	6594	250	32	64 x 70
----------	--	---------------------	----------	-------------	-----	----	---------

1945

1945 AK	340 kW	Max. torque 2180 Nm	88 -> 94	6594	250	32	64 x 70
---------	--------	---------------------	----------	-------------	-----	----	---------

1948

1948		Max. torque 2180 Nm		6594	250	32	64 x 70
------	--	---------------------	--	-------------	-----	----	---------

2024

2024 ...		Max. torque 2180 Nm	93 -> 96	6594	250	32	64 x 70
----------	--	---------------------	----------	-------------	-----	----	---------

2031

2031 ...		Max. torque 2180 Nm	92 -> 96	6594	250	32	64 x 70
----------	--	---------------------	----------	-------------	-----	----	---------

2038

2038 ...		Max. torque 2180 Nm	91 -> 96	6594	250	32	64 x 70
----------	--	---------------------	----------	-------------	-----	----	---------

2044

2044 AS	320 kW	Max. torque 2180 Nm	94 -> 96	6594	250	32	64 x 70
---------	--------	---------------------	----------	-------------	-----	----	---------

2429





2429 ...		Max. torque 2180 Nm	88 -> 94	6594	250	32	64 x 70
----------	--	---------------------	----------	-------------	-----	----	---------

2431





2431 ...		Max. torque 2180 Nm	87 -> 96	6594	250	32	64 x 70
----------	--	---------------------	----------	-------------	-----	----	---------





2433





2433 ...		Max. torque 2180 Nm	87 -> 96	6594	250	32	64 x 70
----------	--	---------------------	----------	-------------	-----	----	---------





			 Engine	 Gearbox - Chassis	 Year	 Code	PARAMETER		
							Ø	Z	Splines
2435									
2435 ...			Max. torque 2180 Nm		87 -> 96	6594	250	32	64 x 70
2527									
2527 ...			Max. torque 2180 Nm		91 -> 96	6594	250	32	64 x 70
2529									
2529			Max. torque 2180 Nm			6594	250	32	64 x 70
2531									
2531 ...	230 kW		Max. torque 2180 Nm		87 -> 96	6594	250	32	64 x 70
2534									
2534 ...			Max. torque 2180 Nm		87 -> 96	6594	250	32	64 x 70
2538									
2538 ...			Max. torque 2180 Nm		91 -> 96	6594	250	32	64 x 70
2544									
2544 ...			Max. torque 2180 Nm			6594	250	32	64 x 70
2550									
2550 ...			Max. torque 2180 Nm		87 -> 96	6594	250	32	64 x 70
2629									
2629 ...			Max. torque 2180 Nm		88 -> 94	6594	250	32	64 x 70
2631									
2631 ...			Max. torque 2180 Nm		88 -> 96	6594	250	32	64 x 70
2634									
2634	250 kW		Max. torque 2180 Nm		92 -> 96	6594	250	32	64 x 70
2635									
2635 ...			Max. torque 2180 Nm		88 -> 94	6594	250	32	64 x 70
2638									
2638 ...			Max. torque 2180 Nm		91 -> 96	6594	250	32	64 x 70
2650									
2650			Max. torque 2180 Nm			6594	250	32	64 x 70
3234									
3234 ...	250 kW		Max. torque 2180 Nm		92 -> 96	6594	250	32	64 x 70
3235									
3235 ...			Max. torque 2180 Nm		88 -> 96	6594	250	32	64 x 70
3238									
3238 ...			Max. torque 2180 Nm		87 -> 96	6594	250	32	64 x 70
3244									
3244 L	320 kW		Max. torque 2180 Nm		87 -> 96	6594	250	32	64 x 70
3253									
3253 ...	390 kW		Max. torque 2180 Nm		96	6594	250	32	64 x 70
3534									
3234 K	250 kW		Max. torque 2180 Nm		93 -> 96	6594	250	32	64 x 70
3535									
3535 ...			Max. torque 2180 Nm		88 -> 94	6594	250	32	64 x 70
3538									
3538 ...			Max. torque 2180 Nm		91 -> 96	6594	250	32	64 x 70
3544									
3544 ...	320 kW		Max. torque 2180 Nm		91 -> 96	6594	250	32	64 x 70

		Engine	Gearbox - Chassis	Year	Code	PARAMETER		
						Ø	Z	Splines
3548								
3548			Max. torque 2180 Nm		6594	250	32	64 x 70
3550								
3550			Max. torque 2180 Nm	88 ->	6594	250	32	64 x 70
4435								
4435 ...			Max. torque 2180 Nm		6594	250	32	64 x 70
4844								
4844 ...			Max. torque 2180 Nm	91 -> 96	6594	250	32	64 x 70
4850								
4850 ...			Max. torque 2180 Nm	87 -> 96	6594	250	32	64 x 70
4853								
4853			Max. torque 2180 Nm		6594	250	32	64 x 70
5038								
5038 ...			Max. torque 2180 Nm		6594	250	32	64 x 70
ACTROS 1824 - 1863								
1831 - 1832 - 1835 - 1836			Max. torque 2180 Nm	97 ->	6562	468	32	64 x 70
1840 - 1841 - 1843 - 1844 - 1846 - 1848			Max. torque 2180 Nm	97 ->	6562	468	32	64 x 70
1850 - 1851 - 1853 - 1854			Max. torque 2180 Nm	96 ->	6562	468	32	64 x 70
ACTROS 2024 - 2055								
2031 - 2032 - 2035 - 2036			Max. torque 2180 Nm	96 ->	6562	468	32	64 x 70
2040 - 2041 - 2043 - 2044 - 2046 - 2048			Max. torque 2180 Nm	96 ->	6562	468	32	64 x 70
2053	390 kW		Max. torque 2180 Nm	96 -> 02	6562	468	32	64 x 70
ACTROS 2427 - 2460								
2432 - 2436 - 2441 - 2444 - 2448			Max. torque 2180 Nm	08 ->	6562	468	32	64 x 70
2451 - 2455 - 2460			Max. torque 2180 Nm	08 ->	6562	468	32	64 x 70
ACTROS 2527 - 2560								
2531 - 2532 - 2535 - 2536			Max. torque 2180 Nm	96 ->	6562	468	32	64 x 70
2540 - 2541 - 2543 - 2544 - 2546 - 2548			Max. torque 2180 Nm	97 ->	6562	468	32	64 x 70
2551 - 2555 - 2558 - 2560			Max. torque 2180 Nm	03 ->	6562	468	32	64 x 70
ACTROS 2627 - 2665								
2631 - 2632 - 2635 - 2636			Max. torque 2180 Nm	96 ->	6562	468	32	64 x 70
2640 - 2641 - 2643 - 2644 - 2646 - 2648			Max. torque 2180 Nm	96 ->	6562	468	32	64 x 70
2650 - 2651 - 2653 - 2654 - 2655			Max. torque 2180 Nm	96 ->	6562	468	32	64 x 70
ACTROS 3231 - 3339								
3231 - 3232 - 3235 - 3236			Max. torque 2180 Nm	97 ->	6562	468	32	64 x 70
3240 - 3241 - 3243 - 3244 - 3246 - 3248			Max. torque 2180 Nm	97 ->	6562	468	32	64 x 70
3331 - 3332 - 3335 - 3336 - 3339			Max. torque 2180 Nm	97 ->	6562	468	32	64 x 70
ACTROS 3340 - 3550								
3340 - 3341 - 3343 - 3344 - 3346 - 3348			Max. torque 2180 Nm	97 ->	6562	468	32	64 x 70
3350 - 3351 - 3353 - 3354 - 3355 - 3360			Max. torque 2180 Nm	97 ->	6562	468	32	64 x 70
ACTROS 4036 - 4844								
4140 - 4141 - 4143 - 4144 - 4146 - 4148			Max. torque 2180 Nm	97 ->	6562	468	32	64 x 70
ACTROS 5041 - 5048								
5041 - 5044 - 5046 - 5048			Max. torque 2180 Nm	08 ->	6562	468	32	64 x 70
ATEGO 1517 - 1730								
1728 S	205 kW		Max. torque 2180 Nm	07 ->	6562	468	32	64 x 70

		 Engine	 Gearbox - Chassis	 Year	 Code	PARAMETER		
						Ø	Z	Splines
ATEGO 1823 - 1929								
1823 - 1828 - 1923 - 1928			Max. torque 2180 Nm	98 ->	6562	468	32	64 x 70
ATEGO 2223 - 2530								
2223 - 2228			Max. torque 2180 Nm	98 -> 04	6562	468	32	64 x 70
2523 - 2528			Max. torque 2180 Nm	98 -> 04	6562	468	32	64 x 70
ATEGO 2436 - 2544								
2528 - 2533			Max. torque 2180 Nm	04 ->	6562	468	32	64 x 70
ATEGO 2623 - 2831								
2628 - 2629 - 2633			Max. torque 2180 Nm	04 ->	6562	468	32	64 x 70
OF Series								
OF 1617			Max. torque 720 Nm.		6590	314	21	41 x 45
NEW HOLLAND								
FIAT AGRI 90 - 180								
130-90		95 kW		84 -> 90	4769	350	14	35 x 40
140-90		103 kW		84 -> 95	4769	350	14	35 x 40
160-90		118 kW		84 -> 95	4769	350	14	35 x 40
180-90		132 kW		84 -> 95	4769	350	14	35 x 40
M Serie								
100 - 115 - 135		74 - 100 kW	Powershift	95 ->	4609	348	14	35 x 40
160		120 kW	Powershift	95 ->	4609	348	14	35 x 40
T 7								
T7.170		126 kW		10 ->	4775	348	14	35 x 40
T7.185		138 kW		10 ->	4775	348	14	35 x 40
T7.200		149 kW		10 ->	4775	348	14	35 x 40
T7.210		156 kW		10 ->	4775	348	14	35 x 40
T7.220		160 kW		10 ->	4775	348	14	35 x 40
T 5000								
5030		56 kW		08 ->	4669	263	14	35 x 40
5040		63 kW		08 ->	4669	263	14	35 x 40
5050		71 kW		08 ->	4669	263	14	35 x 40
5060		78 kW		08 ->	4669	263	14	35 x 40
5070		83 kW		08 ->	4669	263	14	35 x 40
T 6000								
6080		114 kW		09 ->	4775	348	14	35 x 40
6090		121 kW		09 ->	4775	348	14	35 x 40
T 7000								
7030		123 kW		09 ->	4775	348	14	35 x 40
7040		134 kW		09 ->	4775	348	14	35 x 40
7050		145 kW		09 ->	4775	348	14	35 x 40
7060		157 kW		09 ->	4775	348	14	35 x 40
7070		167 kW		09 ->	4775	348	14	35 x 40
TL Serie								
70		53 kW	Powershift	98 ->	4669	263	14	35 x 40
80		60 kW	Powershift	98 ->	4669	263	14	35 x 40
90		67 kW	Powershift	98 ->	4669	263	14	35 x 40
100		70 kW	Powershift	98 ->	4669	263	14	35 x 40

		 Engine	 Gearbox - Chassis	 Year	 Code	PARAMETER		
						Ø	Z	Splines
TLA Serie								
70 A		53 kW	Powershift	04 ->	4669	263	14	35 x 40
80 A		60 kW	Powershift	04 ->	4669	263	14	35 x 40
90 A		67 kW	Powershift	04 ->	4669	263	14	35 x 40
100 A		74 kW	Powershift	04 ->	4669	263	14	35 x 40
TM Serie								
115		78 kW	Semi Powershift	99 ->	4609	348	14	35 x 40
120		91 kW	Semi Powershift	02 ->	4609	348	14	35 x 40
120		91 kW	Full Powershift	02 ->	4775	348	14	35 x 40
125		88 kW	Semi Powershift	99 ->	4609	348	14	35 x 40
130 - 135 - 140 - 150 - 155 - 165		63 - 119 kW	Semi Powershift	99 ->	4609	348	14	35 x 40
130 - 135 - 140 - 150 - 155 - 165		63 - 119 kW	Full Powershift	99 ->	4775	348	14	35 x 40
175 - 190		130 - 142 kW	Full Powershift	02 ->	4775	348	14	35 x 40
TS Serie								
90 - 100 - 110 - 115		66 - 74 kW	Electroshift	97 -> 03	4668	263	10	30,2 x 35,2
TSA Serie								
100 A - 110 A			Dual Command	03 ->	4666	263	16	31 x 35
115 A - 125 A			Dual Command	03 ->	4666	263	16	31 x 35
115 A - 125 A - 135 A		86 - 93 - 100 kW	Electro / Active Command	03 ->	4779	348	16	31 x 35
8000 Serie FORD								
8160				95 ->	4609	348	14	35 x 40
8240 SLE		81 kW		91 -> 96	4668	263	10	30,2 x 35,2
8260				95 ->	4609	348	14	35 x 40
8340 SLE		88 kW		91 -> 98	4668	263	10	30,2 x 35,2
8360				95 ->	4609	348	14	35 x 40
8560				95 ->	4609	348	14	35 x 40
PASQUALI								
AGRICULTURAL								
Coupling					4365	225	16	27 x 30
PAUS								
RL								
RL 45			Max. torque 660 Nm		6578	360	21	31,8 x 35
RENAULT AGRICULTURE								
ARES								
540 RX		4032	Revershift - Chass. -> R0698	97 -> 01	4670	263	26	39 x 42,5
540 RX - RZ		5312		01 -> 05	4776	295	26	39 x 42,5
546 RX - RZ					4776	295	26	39 x 42,5
550 RX		4042	Revershift - Chass. -> R1776	97 -> 01	4670	263	26	39 x 42,5
550 RX - RZ		5322		01 -> 05	4776	295	26	39 x 42,5
566 RX - RZ		5322		02 -> 03	4776	295	26	39 x 42,5
610 RX - RZ		4062	Chass. R1755 ->	97 -> 03	4766	295	26	39 x 42,5
616 RX - RZ		8212	Chass. -> 12145	03 -> 05	4766	295	26	39 x 42,5
620 RX - RZ		4072	Chass. -> R1129	97 -> 01	4670	263	26	39 x 42,5
620 RX - RZ		4072	Chass. R1130 ->	97 -> 02	4766	295	26	39 x 42,5
626 RX - RZ		8222		02 -> 03	4766	295	26	39 x 42,5

	 Engine	 Gearbox - Chassis	 Year	 Code	PARAMETER		
					Ø	Z	Splines
630 RX - RZ	4112	Chass. -> S1296	97 -> 01	4670	263	26	39 x 42,5
630 RX - RZ	4112	Chass. S1297->	97 -> 02	4766	295	26	39 x 42,5
636 RZ	8232		02 -> 03	4766	295	26	39 x 42,5
640 RZ	8242		02 -> 03	4766	295	26	39 x 42,5
656 RZ	8232	Chass. -> 32518	03 -> 05	4766	295	26	39 x 42,5
696 RZ	8242		02 -> 05	4766	295	26	39 x 42,5
710 RZ	8272		97 -> 00	4766	295	26	39 x 42,5
715 RZ	4412		01 -> 02	4767	348	26	39 x 42,5
720 RZ	4422		97 -> 99	4766	295	26	39 x 42,5
725 RZ	4422		99 -> 02	4767	348	26	39 x 42,5
735 RZ	4432		99 -> 02	4767	348	26	39 x 42,5
815 RZ	4312		99 -> 01	4768	352	26	39 x 42,5
816 RZ	4412		02 -> 05	4767	348	26	39 x 42,5
816 RZ	106 kW		02 -> 05	4778	348	26	39 x 42,5
825 RZ	4322		99 -> 02	4768	352	26	39 x 42,5
826 RZ	4322		02 -> 03	4768	352	26	39 x 42,5
826 RZ	4422		02 -> 03	4767	348	26	39 x 42,5
826 RZ	122 kW		02 -> 03	4778	348	26	39 x 42,5
836 RZ	4432		02 -> 03	4767	348	26	39 x 42,5
836 RZ	122 kW		02 -> 05	4778	348	26	39 x 42,5
ATLES							
915 RZ	140 kW		00 -> 02	4768	352	26	39 x 42,5
925 RZ - 926 RZ	160 kW		00 -> 02	4768	352	26	39 x 42,5
935 RZ	184 kW		00 -> 02	4768	352	26	39 x 42,5
936 RZ	154 kW		02 -> 05	4768	352	26	39 x 42,5
TEMIS							
550 X	DPS - H3912	Tractonic		4667	225	16	31 x 35
610 X - Z	H3922	Tractonic		4667	225	16	31 x 35
630 X - Z	H3932	Tractonic		4667	225	16	31 x 35
650 X - Z	H3942	Tractonic		4667	225	16	31 x 35
103-52 Serie							
103-52 TA - TE - TS - TX	R7821	Tractoshift - Tractonic	89 -> 92	4667	225	16	31 x 35
103-54 Serie							
103-54 TA - TE - TS - TX	R7822	Tractoshift - Tractonic	89 -> 92	4667	225	16	31 x 35
106-54 Serie							
106-54 - TL - TM - TS	R7842	Tractoshift - Tractonic	92 -> 00	4667	225	16	31 x 35
110-54 Serie							
110-54 TA - TE - TS - TZ	R7912	Tractoshift - Tractonic	86 -> 00	4667	225	16	31 x 35
120-54 Serie							
120-54 TA - TE - TS - TX - TZ	R7922	Tractoshift - Tractonic	89 -> 98	4667	225	16	31 x 35
133-54 Serie							
133-54 TA - TE - TS - TX - TZ	R7922	Tractoshift - Tractonic	89 -> 98	4667	225	16	31 x 35
145-54 Serie							
145-54 TA - TE - TX - TZ	R7942	Tractoshift - Tractonic	87 -> 94	4667	225	16	31 x 35
155-54 Serie							
155-54 TA - TE - TX - TZ	R7952	Tractoshift - Tractonic	87 -> 94	4667	225	16	31 x 35

					PARAMETER		
	Engine	Gearbox - Chassis	Year	Code	Ø	Z	Splines

RENAULT TRUCKS

C

C 260...	192 - 202 kW	Max. torque 2200 Nm	82 -> 91	6589	250	32	64 x 70
C 280...	192 - 202 kW	Max. torque 2200 Nm	82 -> 91	6589	250	32	64 x 70

G

G 280...	202 kW	Max. torque 2200 Nm	90 -> 91	6589	250	32	64 x 70
G 300...	222 kW	Max. torque 2200 Nm	90 -> 91	6589	250	32	64 x 70

MANAGER

G 280...	195 - 202 kW	Max. torque 2200 Nm	91 -> 96	6589	250	32	64 x 70
G 300...	222 kW	Max. torque 2200 Nm	91 -> 96	6589	250	32	64 x 70
G 330...	240 kW	Max. torque 2200 Nm	91 -> 96	6589	250	32	64 x 70

TBH

280		Max. torque 2200 Nm		6589	250	32	64 x 70
-----	--	---------------------	--	-------------	-----	----	---------

SAME

EXPLORER

85	63 kW		09 ->	4607	263	24	46 X 50
95	70.5 kW		04 -> 07	4607	263	24	46 X 50

SILVER

80 Hydrive	59 kW	Chass. 2140 ->	96 ->	4425	263	24	46 X 50
90 Hydrive	66 kW	Chass. 3043 ->	96 ->	4425	263	24	46 X 50
100.4 Hydrive	74 kW	Chass. -> 1880	96 ->	4425	263	24	46 X 50
100.6 Hydrive	74 kW	Chass. 3234 ->	96 ->	4425	263	24	46 X 50

STEYR

CVT

6130	126 kW		10 ->	4775	348	14	35 x 40
6145	138 kW		10 ->	4775	348	14	35 x 40
6150 - 6160	140 - 149 kW		10 ->	4775	348	14	35 x 40
6165 - 6175	156 - 166 kW		13 ->	4775	348	14	35 x 40

PROFI 4 Serie

4100	74 kW		03 ->	4666	263	16	31 x 35
4110	82 kW	Chass. -> Z7BF50488	07 ->	4779	348	16	31 x 35
4120	89 kW	Chass. -> Z7BF50488	07 ->	4779	348	16	31 x 35
4130	97 kW	Chass. -> Z7BF50488	07 ->	4779	348	16	31 x 35

PROFI 6 Serie



6115	85 kW		03 ->	4666	263	16	31 x 35
6125	92 kW	Chass. Z7BF60001 ->	09 ->	4779	348	16	31 x 35
6140	104 kW	Chass. Z7BF60001 >	09 ->	4779	348	16	31 x 35

VALTRA - VALMET EUROPE

C Serie

90	70 Kw	Max. torque 2719 Nm		4760	352	20	41 x 45
100	74 kW	Max. torque 2719 Nm		4760	352	20	41 x 45
110 - 120	84 - 88 kW	Max. torque 2719 Nm		4760	352	20	41 x 45
130	99 kW	Max. torque 2719 Nm		4760	352	20	41 x 45
150	110 kW	Max. torque 2719 Nm		4760	352	20	41 x 45

		 Engine	 Gearbox - Chassis	 Year	 Code	PARAMETER		
						Ø	Z	Splines
HI Serie								
6250		59 kW	Max. torque 2719 Nm		4760	352	20	41 x 45
6350		66 kW	Max. torque 2719 Nm		4760	352	20	41 x 45
6550		74 kW	Max. torque 2719 Nm		4760	352	20	41 x 45
6650		81 kW	Max. torque 2719 Nm		4760	352	20	41 x 45
6750		77 kW	Max. torque 2719 Nm		4760	352	20	41 x 45
6850		88 kW	Max. torque 2719 Nm		4760	352	20	41 x 45
8050		81 kW	Max. torque 2719 Nm		4760	352	20	41 x 45
8150		92 kW	Max. torque 2719 Nm		4760	352	20	41 x 45
8350		99 kW	Max. torque 2719 Nm		4760	352	20	41 x 45
8450		103 kW	Max. torque 2719 Nm		4760	352	20	41 x 45
8550		118 kW	Max. torque 2719 Nm		4760	352	20	41 x 45
8750		118 kW	Max. torque 2719 Nm		4760	352	20	41 x 45
8950		118 kW	Max. torque 2719 Nm		4760	352	20	41 x 45
M Serie								
120		88 kW	Max. torque 2719 Nm		4760	352	20	41 x 45
130		99 kW	Max. torque 2719 Nm		4760	352	20	41 x 45
150		110 kW	Max. torque 2719 Nm		4760	352	20	41 x 45
T Serie								
120		92 kW	Max. torque 2719 Nm	04 ->	4760	352	20	41 x 45
130		99 kW	Max. torque 2719 Nm	04 ->	4760	352	20	41 x 45
140 ECOPOWER		107 kW	Max. torque 2719 Nm	04 ->	4760	352	20	41 x 45
160		121 kW	Max. torque 2719 Nm	04 ->	4760	352	20	41 x 45
170		129 kW	Max. torque 2719 Nm	04 ->	4760	352	20	41 x 45
180		132 kW	Max. torque 2719 Nm	04 ->	4760	352	20	41 x 45
190		140 kW	Max. torque 2719 Nm	04 ->	4760	352	20	41 x 45
XM Serie								
130		99 kW	Max. torque 2719 Nm		4760	352	20	41 x 45
150		110 kW	Max. torque 2719 Nm		4760	352	20	41 x 45
VÖGELE								
VTM								
651			Max. torque 660 Nm		6578	360	21	31,8 x 35
VOLVO PENTA								
Diesel engine								
AD 31A - AD 31B - AD 31D - AD 31DX			Max. torque 425 Nm		6581	287	26	32 x 34,3
AD 41A - AD 41B - AD 41D			Max. torque 820 Nm		6399	287	26	32 x 34,3
AQ 165A - 170A - 170C			Max. torque 425 Nm		6401	287	26	32 x 34,3
AQAD 30A - 31A - 40A - 40B			Max. torque 425 Nm		6581	287	26	32 x 34,3
AQAD 41A			Max. torque 820 Nm		6399	287	26	32 x 34,3
AQD 21A			Max. torque 425 Nm		6401	287	26	32 x 34,3
BB 165A - 170A - 170C			Max. torque 425 Nm		6401	287	26	32 x 34,3
D 41A - D 41B - D 41D			Max. torque 820 Nm		6399	287	26	32 x 34,3
D3 - 190			Max. torque 800 Nm		9339	275	26	32 x 34,3
D4 - 210/225/260/300			Max. torque 1500 Nm		6568	314	26	32 x 34,3
D6 - 280/310/330/350/370			Max. torque 1500 Nm		6568	314	26	32 x 34,3

	 Engine	 Gearbox - Chassis	 Year	 Code	PARAMETER		
					Ø	Z	Splines
DP - D/D1/D2		Max. torque 820 Nm		6399	287	26	32 x 34,3
DP - D/D1/D2/E/G		Max. torque 425 Nm		6581	287	26	32 x 34,3
DP - E		Max. torque 820 Nm		6399	287	26	32 x 34,3
DP - G		Max. torque 820 Nm		6399	287	26	32 x 34,3
DPH A-B		Max. torque 1500 Nm		6568	314	26	32 x 34,3
DPR A-B		Max. torque 1500 Nm		6568	314	26	32 x 34,3
DPX		Max. torque 820 Nm		6399	287	26	32 x 34,3
DPX		Max. torque 425 Nm		6581	287	26	32 x 34,3
KAD 42A - KAD 42B		Max. torque 820 Nm		6399	287	26	32 x 34,3
MD 21		Max. torque 420 Nm		6579	267	26	32 x 34,3
MD 22		Max. torque 265 Nm		6584	157	20	20,1 x 22,6
MD 30A - 31A - 40A		Max. torque 425 Nm		6581	287	26	32 x 34,3
TAMD 30A - 31A - 31D - 40A - 40B		Max. torque 425 Nm		6581	287	26	32 x 34,3
TAMD 41A - TAMD 41B		Max. torque 820 Nm		6399	287	26	32 x 34,3
TMD 30A - 31A - 31B - 31D - 40A - 40B - 40C		Max. torque 425 Nm		6581	287	26	32 x 34,3
TMD 41A - TMD 41B		Max. torque 820 Nm		6399	287	26	32 x 34,3
Gasoline engine							
230 A - B		Max. torque 425 Nm		6581	287	26	32 x 34,3
250 A - B		Max. torque 425 Nm		6581	287	26	32 x 34,3
251 A		Max. torque 425 Nm		6581	287	26	32 x 34,3
AQ 115A - 115B - 120B - 125A - 125B		Max. torque 425 Nm		6581	287	26	32 x 34,3
AQ 115A - 115B - 130A - 130B - 130C - 130D		Max. torque 265 Nm		6580	267	10	20,6 x 25,8
AQ 130 A/B/C/D - AQ 131 A/B/C/D		Max. torque 425 Nm		6581	287	26	32 x 34,3
AQ 140A - 145A - 145B - 151 A/B/C		Max. torque 425 Nm		6581	287	26	32 x 34,3
AQ 165A - 170A - 170B - 170C		Max. torque 425 Nm		6401	287	26	31,8x34,3
AQ 171A - 171C		Max. torque 425 Nm		6581	287	26	32 x 34,3
AQD 21A		Max. torque 425 Nm		6401	287	26	31,8x34,3
BB 115A - 115B - 115C		Max. torque 265 Nm		6580	267	10	20,6 x 25,8
BB 165A - 170A - 170B - 170C		Max. torque 425 Nm		6401	287	26	31,8x34,3
MB 20A - 20B - 20C		Max. torque 265 Nm		6580	267	10	20,6 x 25,8
MB 20A - 20B - 20C		Max. torque 425 Nm		6581	287	26	32 x 34,3

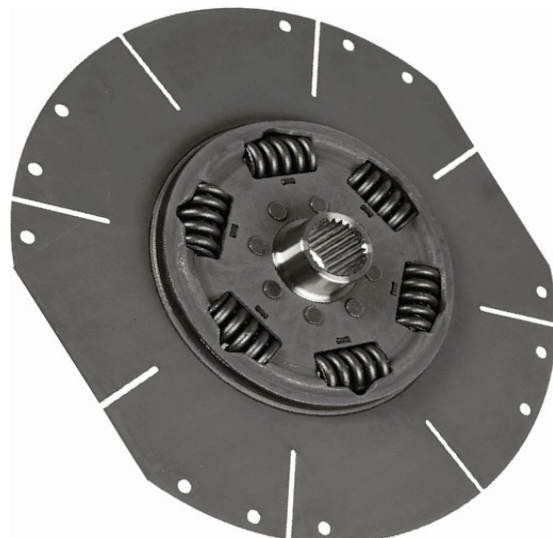
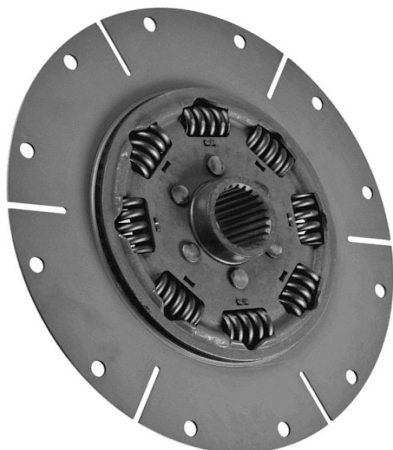

Part number list

E. SASSONE	ZF	LuK	OEM part number
4199	1866 050 002	=	3306316001 - Hurt
4200	1866 052 001	=	3306316003 - Hurt
4304	1866 075 001	=	AL32964 - JD
4365	=	370 0014 10	=
4425	=	370 0030 10	000853943/20 - SAME
4454	1866 052 002	=	3307316001 - Hurt
4455	1866 107 001	=	8105631 - Iveco
4607	1866 600 021	370 0030 10	00113942.4 - SAME
4609	1866 600 011	370 0010 10	5187 845 - CNH
4665	1866 000 150	=	06647110 - Claas
4666	1866 600 004	370 0025 10	3648 843 M91 - Landini
4667	1866 600 005	370 0001 10	77 00 019 282 - Renault
4668	1866 600 010	370 0009 10	8200 8857 - CNH
4669	1866 600 013	370 0017 10	518 7958 - CNH
4670	1866 600 006	370 0002 10	77 00 046 743 - CNH
4671	1866 068 001	=	5603280 - Liebherr
4672	1866 142 001	=	02114585 - Mengele
4709	1878 600 568	328 0388 10	A190182 - Case
4724	=	370 0061 10	4205236M91 - Landini
4727	=	=	=
4732	=	370 0016 10	5817 1703 - Ferrari
4736	1866 104 001	=	=
4760	1866 000 154	370 0052 10	35652400 - Valtra
4763	1866 129 001	=	539958020010 - Steyr
4764	1866 600 014	370 0020 10	3909719M1 - MF
4765	1866 600 003	370 0022 10	3652970M91 - MF
4766	1866 600 007	307 0004 10	7700052774 - Claas
4767	1866 600 008	370 0007 10	7700050636 - Claas
4768	1866 600 009	370 0008 10	7700053637 - Claas
4769	1866 600 012	370 0011 10	5153359 - New Holland
4770	1866 600 015	370 0021 10	3790735M2 - MF
4771	1866 600 016	370 0023 10	3792448M2 - MF
4772	1866 600 017	370 0024 10	3790734M3 - MF
4773	1866 600 018	370 0027 10	3793648M1 - MF
4775	1866 600 022	370 0032 10	87542609 - MF
4776	1866 600 024	370 0040 10	7700067040 - Claas
4777	1866 600 025	370 0041 10	3815739M2 - MF
4778	1866 600 028	370 0013 10	7700057918 - Claas
4779	1866 600 029	370 0062 10	47127700 - Case
5182	1866 061 001	=	3306316002 - Hurt
5192	=	370 0016 10	58173493 - BCS
5233	1862 061 002	=	3307316002 - Hurt
6063	1866 133 001	=	567974 - Liebherr
6064	1866 065 001	=	5602880 - Liebherr

E. SASSONE	ZF	LuK	OEM part number
6065	1866 090 001	=	5603810 - Liebherr
6067	1866 054 002	=	5003708 - Liebherr
6150	1866 156 001	=	5009663 - Liebherr
6155	1866 135 001	=	5608138 - Liebherr
6305	1866 000 108	=	0006447120 - Claas
6352	1866 122 003	=	=
6389	1866 136 001	=	5006801 - Liebherr
6390	1866 138 101	=	5007636 - Liebherr
6391	1866 000 062	=	10100069 - Liebherr
6392	1866 000 079	=	10228100 - Liebherr
6393	1866 000 007	=	10016633 - Liebherr
6394	1866 000 021	=	10022829 - Liebherr
6395	1866 157 101	=	10003465 - Liebherr
6396	1866 000 151	=	10116024 - Liebherr
6397	1866 157 103	=	10016872 - Liebherr
6399	1866 118 001	=	855617 - Volvo
6400	=	=	855389 - Volvo
6401	1866 018 131	=	824991 - Volvo
6561	1866 000 030	=	8.383.343.000.0 - KÄSSBOHRER
6562	1866 000 072	=	=
6564	1866 000 144	=	8.383.354.000.0 - KÄSSBOHRER
6565	1866 000 153	=	10218079 - LIEBHERR
6566	1866 000 175	=	8.383.347.000.0 - KÄSSBOHRER
6568	1866 000 239	=	3886887 - Volvo Penta
6569	1866 000 323	=	5602880 - LIEBHERR
6570	1866 000 332	=	5607974 - LIEBHERR
6571	1866 000 337	=	5608138 - LIEBHERR
6572	1866 000 405	=	10354395 - LIEBHERR
6573	1866 000 437	=	270081381 - KRONE
6574	1866 000 471	=	5603810 - - LIEBHERR
6576	1866 018 143	=	56035041 - Volvo
6578	1866 024 001	=	1 848 491 087 - PAUS
6579	1866 026 131	=	829132 - Volvo Penta
6580	1866 031 101	=	841896 - Volvo Penta
6581	1866 032 231	=	855389 - Volvo Penta
6582	1866 035 202	=	5002324 - LIEBHERR
6583	1866 039 001	=	829476 - Volvo
6584	1866 061 004	=	854345 - Volvo Penta
6586	1866 066 001	=	0262203 - Steinbock
6587	1866 090 002	=	5604578 - LIEBHERR
6588	1866 093 001	327 0019 20	8.133.831.201.46 - Evobus
6589	1866 096 002	=	104671 - IRISBUS
6590	1866 098 033	=	000 250 16 06 - MB
6593	1866 122 006	=	5264637625 - Fuchs
6594	1866 130 001	=	112319 - IRISBUS
9339	1866 000 140	=	3807988 - Volvo